

Operating Instructions: Cable Detector



In order to be able to use the cable detector to the full, read the operating instructions attentively and completely before taking the device into operation, and store this document where it is easily accessible

Table of Contents

1. SCOPE OF DELIVERY	4
2. SAFETY INSTRUCTIONS	5
3. OVERVIEW	8
3.1 PRODUCT INTRODUCTION	8
3.2 CHARACTERISTICS OF THE CABLE DETECTOR	9
3.3 DESCRIPTION AND FUNCTION	10
3.3.1 TRANSMITTER ILLUSTRATION	10
3.3.2 TRANSMITTER DISPLAY	10
3.3.3 RECEIVER ILLUSTRATION	11
3.3.4 RECEIVER DISPLAY	11
3.3.5 RECEIVER DISPLAY IN SEARCH MODE	11
4. MEASURING PROCEDURE	12
4.1 SAFETY PROCEDURES DURING MEASURING	12
4.2 FUNCTIONAL PRINCIPLE	12
4.3 EXAMPLES OF TYPICAL APPLICATIONS	14
5. FIRST USE	14
5.1 SINGLE-POLE USE	14
5.1.1 IN OPEN CIRCUITS	14
5.1.2 DETECTING CABLE BREAKS	16
5.1.3 DETECTING CABLE BREAKS	16
5.1.4 DETECTING LINE BREAKS WITH TWO TRANSMITTERS	17
5.1.5 FAULT DETECTION IN DEFECTIVE ELECTRIC UNDERFLOOR HEATING	18
5.1.6 LOCATING BLOCKAGES IN NON-CONDUCTIVE LINES	19
5.1.7 LOCATING METAL WATER AND HEATING PIPES	20
5.1.8 FINDING A CIRCUIT IN A STOREY	21
5.1.9 TRACKING LINES UNDER PLASTER	22
5.2 TWO-POLE USE	23
5.2.1 USE IN CLOSED CIRCUITS	23
5.2.2 DETECTING FUSES	24
5.2.3 LOCATING THE CAUSE OF A SHORT-CIRCUIT	25
5.2.4 LOCATING DEEPLY COVERED POWER CABLES	26
5.2.5 CLASSIFYING OR IDENTIFYING A COVERED CIRCUIT	27
5.3 METHOD TO INCREASE THE EFFECTIVE RADIUS WHEN DETECTING LIVE CIRCUITS	28
5.4 IDENTIFYING GRID VOLTAGE AND SEARCHING FOR BREAKS IN CIRCUITS	29
6. OTHER FUNCTIONS	30
6.1 VOLTMETER FUNCTION OF THE TRANSMITTER	30
6.2 FLASHLIGHT FUNCTION	30
6.3 BACKGROUND LIGHTING	30

6.4 SILENT FUNCTION	30
6.5 AUTOMATIC SWITCH-OFF	30
<u>7. TECHNICAL PARAMETERS</u>	<u>31</u>
7.1 TECHNICAL PARAMETERS OF THE TRANSMITTER	31
7.2 TECHNICAL PARAMETERS OF THE RECEIVER	31
<u>8. REPAIR AND MAINTENANCE</u>	<u>31</u>
8.1 TROUBLESHOOTING	31
8.2 CHECK THE TRANSMITTER FUSE.	32
8.3 CLEANING	33
8.4 CHANGING THE BATTERY	33
8.5 CALIBRATION	33
<u>9. ADDRESSES</u>	<u>34</u>
<u>10. LEGAL NOTICE</u>	<u>34</u>

1. Scope of delivery

Examine the cable detector carefully after opening the package and make sure that it was not damaged during shipping. Thoroughly check the accessories, control switch and connections. If there is obvious damage or a malfunction, contact the supplier immediately.

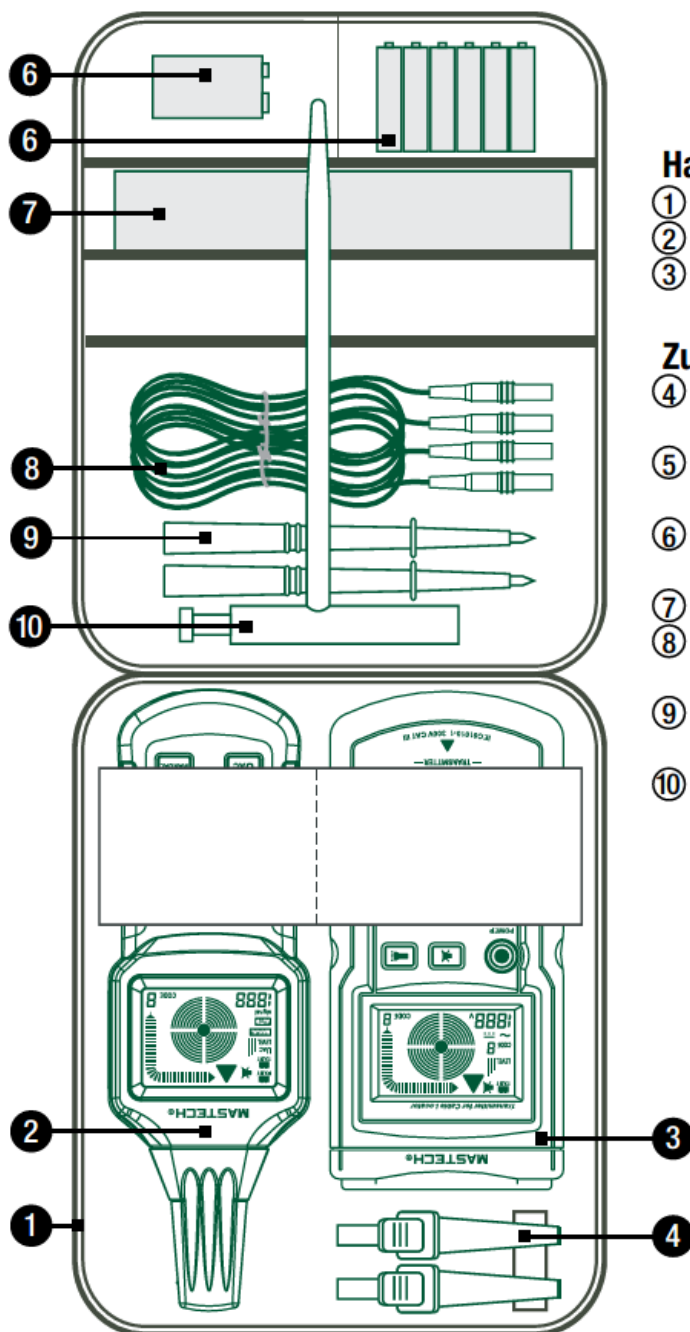

Hauptteile:

- ① Tasche
- ② Empfänger: 1 St.
- ③ Transmitter: 1 St.

Zubehör:

- ④ Krokodilklemmen: 2 St.
(jeweils rot und schwarz)
- ⑤ Batterie: 1 St.
(alkalische Batterie, 9 V, GL6F22A 1604A)
- ⑥ Batterie: 6 St.
(alkalische Batterie, 1,5 V, AAA, Größe LR03)
- ⑦ Bedienerhandbuch: 1 St.
- ⑧ Prüflleitungen: 2 St.
(1,5 m lang, jeweils rot und schwarz)
- ⑨ Prüfsonde: 2 St.
(jeweils rot und schwarz)
- ⑩ Erdungsstab

2. Safety instructions

⚠️ WARNUNG
<p>This cable detector has been manufactured in accordance with the applicable safety requirements for electronic test and measurement instruments, and was completely checked prior to packaging and shipping. Please read these operating instructions carefully before taking the device into operation, and follow all instructions. Failure to follow the instructions or to comply with the warnings and safety instructions in this manual can lead to damage to the equipment, severe injury, or death.</p>

Definition of safety instructions

Table 1: Safety symbols







	Important information that the user must read before first use of the equipment.
	Shows that this connection can be hazardous.
	Conformity mark

Table 2: Warnings

	Improper use can lead to severe injury or death.
	Improper use or negligence can lead to injury, damage to the equipment, or false measurement results.
	Notes and tips for use.



Important!

Please follow these instructions in order to ensure safe operation and good performance.

1.) Pre-check

Before use, check to see that the cable detector functions properly and make sure that it was not damaged during storage and transport. If there is damage, do not take the unit into use. Contact the vendor.

⚠️ WARNUNG	When using the cable detector always make sure to follow the applicable electronic industry safety regulations.
-------------------	---

2.) Storage

Operating temperature	0-40°C (32-104°F, <80%RH (no condensation))
Storage temperature	-20 - +60°C (-6 – 140°F), <80%RH (no condensation)

To prevent defects and faults, never store the cable detector in the following environments:

 Direktes Sonnenlicht oder hohe Temperaturen	 Staub	 Starke elektromagnetische Strahlung
 Spritzwasser, hohe Feuchtigkeit oder Kondenswasser	 Korrosive oder explosive Gase	 Mechanische Vibration

3.) Operation



Follow these instructions to prevent shock, short-circuits and explosions:

1. This cable detector can be used directly with parts conducting current. However, take insulation measures in accordance with industry safety regulations in order to prevent shocks and injury.
2. To prevent shocks the applicable safety and VDE rules relating to excess contact voltages must be followed carefully when working with voltages over 120 V (60 V) DC of 50 V (25 V) effective AC. The amounts in brackets apply for specific areas (such as medicine and agriculture).
3. Never try to make contact between the two battery terminals, for example with a cable connection. Never throw the battery into a fire, as it may explode.
4. When replacing or changing the battery, make sure of correct polarity. Incorrect battery polarity can destroy the device. There is also a risk of explosion and/or fire.

⚠️ WARNUNG

1. Measurements in dangerous proximity to electrical systems may be made only under the direction of a responsible electrician.
2. If the device is used to test a live wire, make sure that the test lead is removed from the component under test before connecting or disconnecting the test lead of the transmitter, and tell people in the vicinity to protect themselves well.
3. Never attempt to disassemble the batteries! The batteries contain very strongly alkaline chemicals. They can cause chemical burns. If the contents of the battery come into contact with skin or clothing, rinse immediately with water and remove contaminated clothing. If the contents of the battery come into contact with the eyes, rinse immediately with water and get medical help.
4. Connecting the transmitter to the grid can generate a current in the milliamperere range in the circuit in live condition, so the transmitter can be grounded only on a neutral conductor. If the transmitter connection is from the phase to the protective conductor, the functional safety of the protective conductor must first be tested per DIN VDE 0100, because all components connected to ground when the transmitter is connected from phase to ground can become live in the event of a fault (if the grounding resistance is not in accordance with requirements).
5. If operator safety is no longer assured, the test device must be taken out of operation and secured against further use. Safety is no longer assured if the device:
 - Has obvious damage;
 - Does not perform the desired measurements;
 - Was stored too long under unfavourable conditions;
 - Was mechanically stressed during transportation.
6. The test device may be used only for the intended purpose under the intended conditions. Operating safety is no longer assured if the device is modified or altered.

⚠️ VORSICHT

1. The operating temperature of the cable detector is between 0 - 40 °C (32 -104 °F).
2. To avoid damage, the device should be protected from excessive mechanical vibration during use, and especially against falling.
3. Only persons with the proper knowledge may calibrate and repair this instrument.
4. Before use, check the instrument and the test leads used for external damage. Make sure that the test device and test leads are intact. The instrument may be used only after all of its functions have been thoroughly prepared for the use.
5. When the device is in use, the rated voltage of the conductor under test may not be greater than the rated voltages given in the technical specifications of this cable detector.
6. Protect the device from direct sunlight, to ensure proper functioning and long operating life.
7. If the test device is exposed to an extremely strong electromagnetic field, its functioning may be impaired.
8. Use only the batteries named in the Technical Specifications section.
9. Protect the batteries from moisture. If a blinking battery symbol appears on the display, the batteries need to be replaced.

HINWEIS

1. If the cable detector has been stored or transported under extreme climate conditions, leave it in a permissible (rated) environment for a while before using.
2. If the transmitter is connected to a live grid and the ground connection of the transmitter is connected to a ground protective phase, the fault current (if present) in the power supply line can combine with the current in the transmitter circuit to trip the fault-current circuit breaker i.e. trigger FI/RCD.
3. Please keep the original packaging for later shipping (for example, for calibration).

3. Overview

3.1 Product introduction

When you cut a hole in a wall to install air conditioning, dig a hole in the ground to install a machine, or dig up a road, you first have to check the location of cables, water pipes and gas lines, to avoid them and prevent unnecessary problems and hazards. Up until now there was only one way to do this - examining the technical drawings of the installations concerned. But often these drawings are impossible to find, so you have to hope for the best and work blind. This can cut cables and pipelines, and lead to power outages, shocks, explosions and even loss of life.

The cable detector 37270766 sold by our company helps users find cables and lines. You no longer have to just rely on luck. This cable detector is portable and consists of a transmitter, receiver and some accessory components. With its modern integrated components and digital circuitry, it is very stable and reliable. The transmitter sends to the cable (or metal pipe) being searched for an alternating voltage modulated by digital signals. This voltage generates an alternating field. If you hold the sensor head of the receiver near the field, the sensor generates an induced voltage. The device amplifies the weak voltage signal several hundred times, and then based on the signal changes, and after decoding the audio frequency, demodulation and digital processing, shows the position of hidden cables and pipes as well as their defects on an LCD screen.

The cable detector is user friendly and features pushbutton operation with confirmation by a buzzer. It also has a visual display, transmitter and receiver with LED lights. The transmitter doesn't just transfer signals, but also acts as an AC/DC voltage meter, so that the instrument can show the tested conductor, including AC/DC status and a warning if a live conductor is tested. The transmitter also has a self-test function that shows on the display if the transmitter is sending signals, giving the user more certainty when testing. The receiver display is backlit so that users can see the test results in the dark as well. To improve testing efficiency, the receiver has a loudspeaker that sounds different tones for different signal intensity levels, so that the user can assess the test results audially for added convenience. The loudspeaker adapts to loud environments with increased volume. Naturally there is also a soundless mode for transmitter and receiver to avoid disturbing others. This cable detector is intended for construction work involving telephone, power and building lines, as well as for maintenance work on these cables and pipelines.

3.2 Characteristics of the cable detector

- Detects cables, electric, water and gas supply lines in walls and in the ground.
- Detects breaks and short-circuits in electric lines in walls and in the ground.
- Locates fuses and maps them to circuits.
- Locates plug sockets and junction boxes inadvertently plastered over.
- Detects breaks and short-circuits in underfloor heating.
- The transmitter has an integral AC/DC voltmeter function that can linearly measure direct and alternating voltage from 12 to 400 V.
AC~: 12 to 400V (50 to 60 Hz) to 2.5%
DC=: 12 to 400V to 2.5%
- The transmitter display can show the preset transmitter power, the codes sent, the energy remaining in the unit's battery, the grid voltage found, the AC/DC status of that voltage and a warning signal that grid voltage is present.
- The transmitter has a self-test function that detects its status and shows it to the user on the LCD display.
- The receiver display can show the transmitter power, the codes sent, the energy remaining in its battery and that of the transmitter, the AC signal found and a warning signal for grid voltage.
- The receiver sensitivity can be set manually or automatically.
- The receiver can determine the frequency automatically.
- Both the transmitter and the receiver can be operated in silent mode.
- The receiver is available with automatic switch-off (switches off automatically if no button is pressed for over 10 minutes).
- The receiver LCD display is backlit for use in low light.
- Both the transmitter and the receiver have a flashlight function for use in low light.
- Additional transmitters are available to extend the system or differentiate multiple signals.
- The cable detector is compact, robust and portable.

3.3 Description and function

3.3.1 Transmitter illustration

- ① LCD-Display
- ② Taste Strom ein/aus
- ③ Taste zum Einstellen/Bestätigen der Sendeleistung (Leistung I, II oder III)
- ④ Taste zur Übertragung oder zum Übertragungsstopp der Code-Informationen
- ⑤ Taste zum Einstellen/Bestätigen der zu übertragenden Code-Informationen; Taste 1 Sekunde drücken, um die Code-Einstellungen einzugeben, und kurz drücken, um die Einstellfunktion zu verlassen (es können die Codes F, E, H, D, L, C, O oder A ausgewählt werden; Standardeinstellung ist F)
- ⑥ Taste „Ab“: Drücken, um beim Einstellen der Leistung oder des Codes einen tieferen Wert zu erhalten
- ⑦ Taste „Auf“: Drücken, um beim Einstellen der Leistung oder des Codes einen höheren Wert zu erhalten
- ⑧ Taste zur Aktivierung oder Deaktivierung des Leise-Modus (kein Tastaturton im Leise-Modus)
- ⑨ Taste zum Ein-/Ausschalten der Taschenlampenfunktion
- ⑩ Öffnung „+“: Ein-/Ausgabeöffnung des Transmitters; der Transmitter wird über diese Öffnung mit der Prüfleitung an externe Kabel angeschlossen, um Signale zu senden und die gefundenen Spannungssignale zu empfangen
- ⑪ Erdungsöffnung: der Transmitter wird über diese Öffnung mit der Prüfleitung geerdet

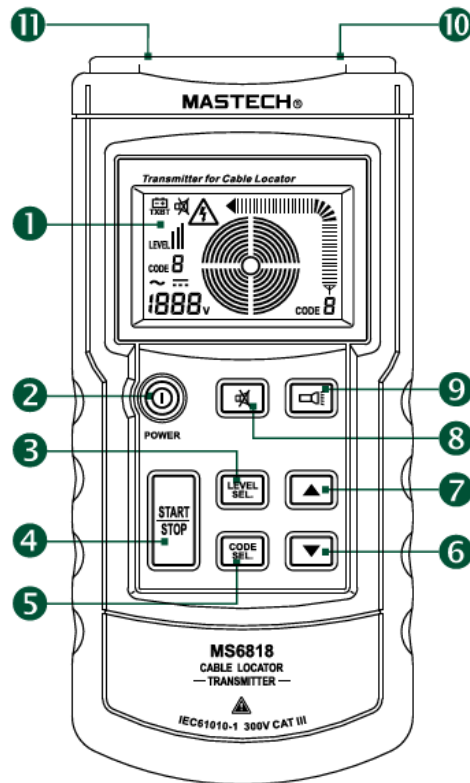

3.3.2 Transmitter display

- ① Symbol zur Anzeige der Spannung /Energie der Batterie des Transmitters
- ② Sendeleistung (Leistung I, II oder III)
- ③ Übertragungs-Code (standardmäßig F)
- ④ Netz-Wechselspannung
- ⑤ Netz-Gleichspannung
- ⑥ Netzspannungswert (kann als normaler Spannungsmesser genutzt werden; Bereich: 12 bis 400 V DC/AC)
- ⑦ Übertragungsstatus
- ⑧ Code, der übertragen wird
- ⑨ Intensität des übertragenen Signals
- ⑩ Symbol zur Anzeige der Netzspannung
- ⑪ Symbol zur Anzeige des Leise-Modus

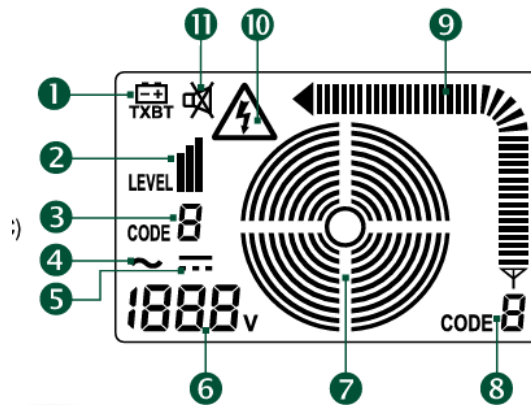

3.3.3 Receiver illustration

- ① Taschenlampe
- ② Sensorkopf
- ③ LCD-Display
- ④ Taste Strom ein/aus
- ⑤ Gemeinsame Taste für Hintergrundbeleuchtung und Leise-Modus; kurz drücken, um die Hintergrundbeleuchtung zu aktivieren/deaktivieren, und 1 Sekunde lang drücken, um den Leise-Modus zu aktivieren/deaktivieren (im Leise-Modus sind sowohl der Tastaturton als auch der Lautsprecher leise)
- ⑥ Taste zum Ein-/Ausschalten der Taschenlampe
- ⑦ UAC-Taste zum Umschalten zwischen Kabelsuchmodus und Netzspannung
- ⑧ Taste „MANUELL“ zum Umschalten zwischen manueller und automatischer Kabelsuche
- ⑨ Taste zum Einstellen der Empfindlichkeit nach unten im manuellen Modus
- ⑩ Taste zum Einstellen der Empfindlichkeit nach oben im manuellen Modus
- ⑪ Lautsprecher

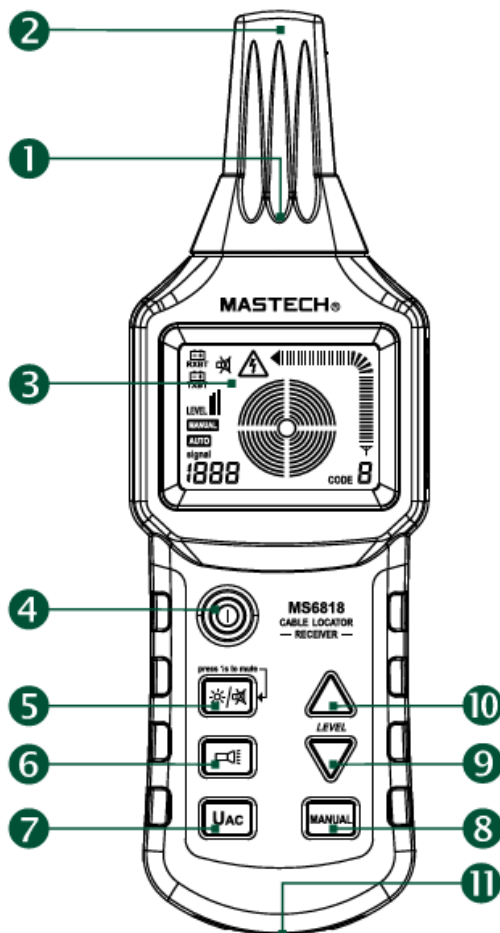

3.3.4 Receiver display

- ① Symbol zur Anzeige der Spannung/Energie der Batterie des Empfängers
- ② Symbol zur Anzeige der Spannung/Energie der Batterie des Transmitters
- ③ Empfangene Sendeleistung (Leistung I, II oder III)
- ④ Symbol für den manuellen Modus
- ⑤ Symbol für den Automatik-Modus
- ⑥ Im Automatik-Modus zeigt diese Zahl die Signalintensität an; im manuellen Modus zeigt diese Stelle „SEL“, d.h. kein Signal, oder eine Zahl, die der Signalintensität entspricht, an; im UAC-Modus zeigt diese Stelle „UAC“ an
- ⑦ Konzentrische Kreise stellen die voreingestellte Empfindlichkeit grafisch dar; mehr Kreise bedeuten eine höhere Empfindlichkeit, während weniger Kreise eine niedrigere Empfindlichkeit darstelle
- ⑧ Code empfangen
- ⑨ Signalintensität
- ⑩ Symbol zur Anzeige Netzspannung
- ⑪ Symbol zur Anzeige des Leise-Modus

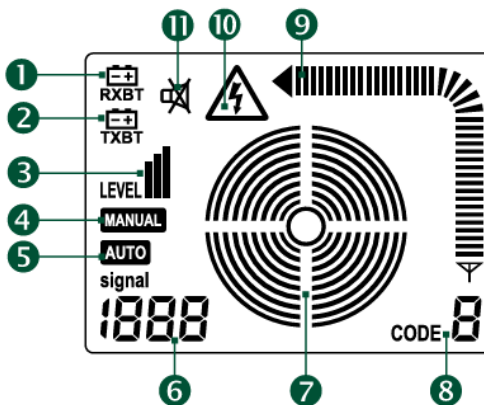

3.3.5 Receiver display in search mode

(1) Automatic mode

(2) Manual mode

(3) Grid voltage detection

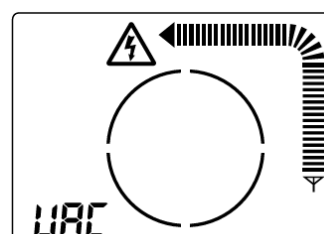
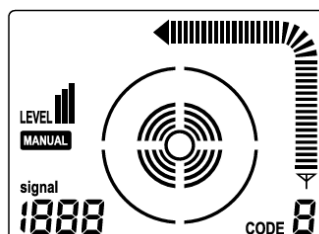
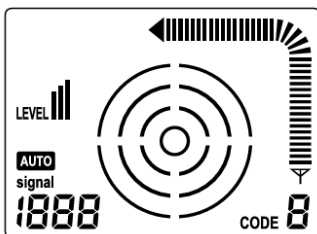

4. Measuring procedure

4.1 Safety procedures during measuring

⚠ WARNING
<ol style="list-style-type: none">1. Connecting the transmitter to the grid supply can generate a current of a few milliamperes in the circuit in live condition; accordingly, the transmitter can be grounded only on a neutral conductor. If the transmitter connection is from the phase to the protective conductor, the functional safety of the protective conductor must first be tested per DIN VDE 0100. Because all components connected to ground are then connected to ground by the transmitter with the phase, meaning that they can become live in the event of a fault (if the grounding resistance is not in accordance with requirements).2. If the transmitter is connected to a live grid and the ground connection of the transmitter is connected to a ground phase, the fault current (if present) in the power supply line can combine with the current in the transmitter circuit to trip the fault-current circuit breaker i.e. trigger FI/RCD.
HINWEIS
<ol style="list-style-type: none">1. When using the transmitter as a voltmeter to test grid voltage, there is often a small spark when the measurement sensor touches grid voltage. This is a normal reaction.2. If the Start/Stop, Code Set or Level Set key is active, the other two are inactive.3. If the receiver is operating in automatic mode, it can be switched to manual mode or grid voltage ident mode at any time; if the receiver is set to manual mode, the UAC or MANUAL key is reactivated only after leaving manual mode.

4.2 Functional principle

This cable detector is portable and consists of a transmitter, receiver and some accessory components. To locate a cable (or metal pipe) the transmitter sends an alternating voltage modulated by digital signals. This voltage generates an alternating field (see Fig. 2-1). If you hold the sensor of the receiver near the field, the sensor generates an induced voltage. This device amplifies this weak voltage signal several hundred times, and then based on the signal changes, and after decoding the audio frequency, demodulation and digital processing, shows the position of hidden cables and pipes as well as their defects on an LCD screen.

⚠ VORSICHT
<ol style="list-style-type: none">1. For all applications the transmitter connections must form a closed circuit.2. This cable detector can only detect and locate lines that are connected correctly per the described physical principles.

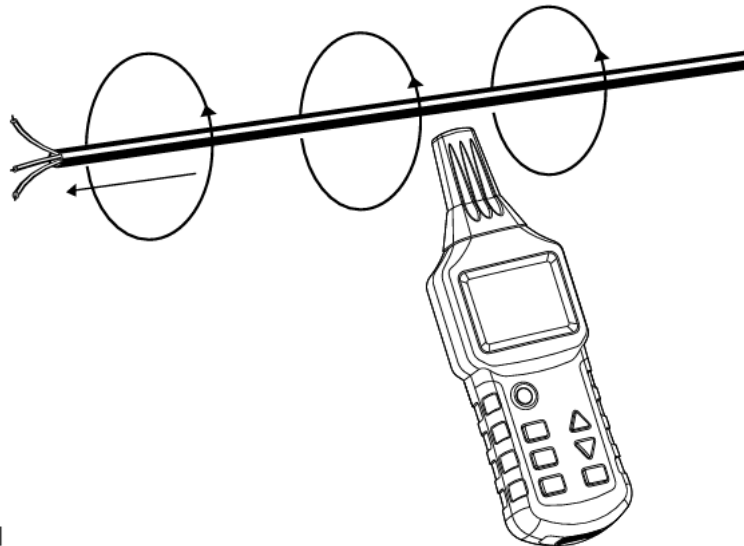

Fig. 2-1

HINWEIS

Optional connection types

1. **Single-pole use:** Connect the transmitter with just one lead. The high frequency signal generated by the transmitter can detect and track only one conductor. The second conductor is ground. This configuration generates a high frequency current that flows through the conductor and on to ground, similar to a radio or receiver.
 2. **Double-pole use:** The transmitter is connected to the conductor by two test leads. This configuration can detect live and voltage-free lines.
- **The transmitter is connected to live wires:**
Connect the + terminal of the transmitter to the grid conductor phase and the ground terminal of the transmitter to the grid neutral conductor. If the grid wire is not live, the modulated current from the transmitter will pass through the distributed capacity in the grid line to the neutral wire and return to the transmitter.
 - **The transmitter is connected to voltage-free wires:**
Connect the + terminal of the transmitter to a grid neutral connection. Connect the ground terminal to another parallel grid wire and connect the two other grid connections to each other. In this case the modulated current returns directly to the transmitter through the grid wire. Optionally, the two transmitter test leads can be connected to the two ends of the conductor. The + terminal of the transmitter can be connected to the grid line, and the ground terminal of the transmitter to the grid's protective ground lead.

4.3 Examples of typical applications

For this example you will need a length of shielded cable with a 1.5 mm² cross section. Install 5 m of the cable temporarily on a wall at eye level using nail clamps. The wall should be accessible from both sides. Make a break in the line 1.5 m away from the transmitter connection. The wire connections must be open and accessible. Cover up the interrupted wire strands at the break and connect the cable to the transmitter terminal (10) using the supplied test leads. Connect the terminal 11 of the transmitter to a suitable ground connection. All other strands in the cable should also be connected to the transmitter and the same ground. (see Fig. 2-2).

Turn on the transmitter by pressing the key (2). When the transmitter LCD display shows the starting image the buzzer will sound. Press key (3) on the transmitter to get to the display for setting transmission power, then press “up” (7) or “down” (6) to select the power (level I, II or III). Once the power is set, press key (3) to exit the display. To change the transmission code, press transmitter key (5) and hold it down for about a second, then press “up” (7) or “down” (6) to select the transmission code (F, E, H, D, L, C, O or A, default F). Press key (5) to exit. Then press key (4) to send the information. The LCD display will show concentric circles (7) gradually spreading out. Symbol (8) shows the transmission code received from the transmitter, and (9) shows the signal strength. Press receiver key (4) to switch it on. When the receiver LCD display shows the starting image the buzzer will sound, and the receiver will go to automatic mode by default. Slowly move the receiver probe along the cable until you reach the break. When the symbol (3) of the receiver shows the transmission power, (8) will show the code sent by the transmitter and (9) the dynamic signal strength. The loudspeaker will change its pitch to reflect the signal intensity change. When the receiver probe passes the break, the signal intensity shown in (9) and (6) will show a sudden decline and disappear entirely. When this happens, press the “MANUAL” key (8) on the receiver to switch to manual mode, then use keys (9) and (10) to reduce the sensitivity as far as possible while making sure that (8) the code sent by the transmitter is visible on the receiver display. This is the area where the line break was detected.

5. First use

5.1 Single-pole use

5.1.1 In open circuits

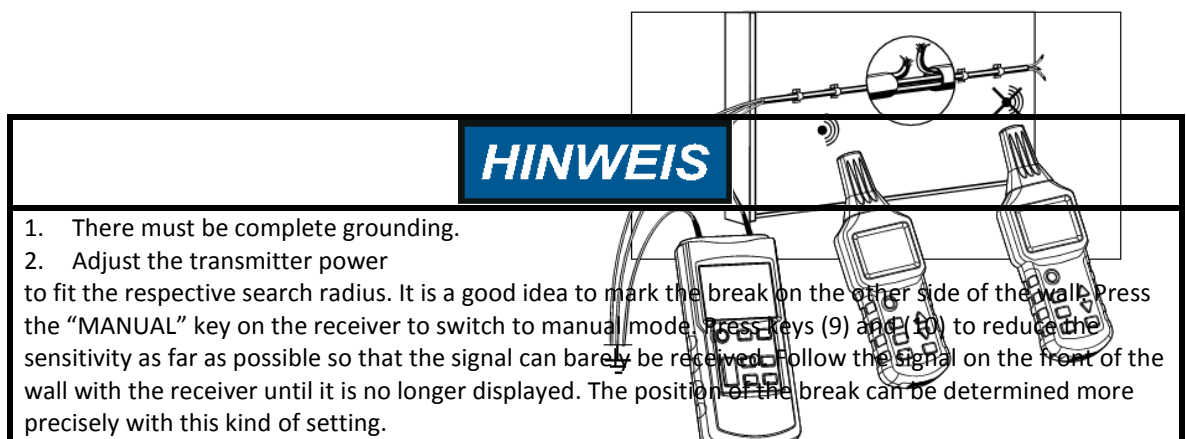

Fig. 2-2

- Detecting cable breaks in walls and floors;
- Locating and tracking cables, sockets and plugs, switches etc. in home installations
- Finding bottlenecks, kinks, bends and clogs in installed pipes with the help of a metal wire

⚠ VORSICHT
For these applications make sure the ground conductor is functional.

HINWEIS

1. Use in open circuits is suitable for locating sockets and switches that are not bearing current.
2. The tracking depth depends on the material and the conditions of use. The ideal tracking depth is 0 to 2 m. The protective conductor of a plug socket can be used to ground the transmitter.

5.1.2 Locating and tracking wires and sockets

Requirements:

- The circuit must **not** be live.
- The neutral and protective leads must be connected and fully functional.
- Connect the transmitter to the phase and protective ground per Fig. 3-1-2.

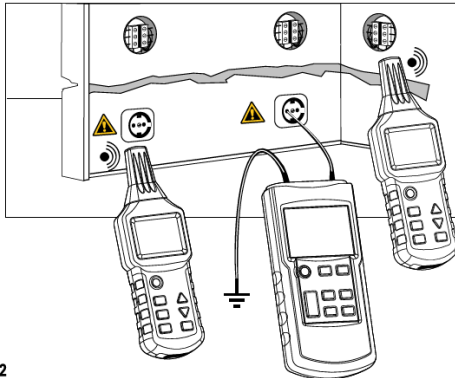

Fig. 3-1-2

5.1.3 Detecting cable breaks

Requirements:

- The circuit must not be live.
- All leads not needed must be connected to auxiliary ground per Fig. 3-1-3.
- Connect the transmitter with a line connection and auxiliary ground per Fig. 3-1-3.

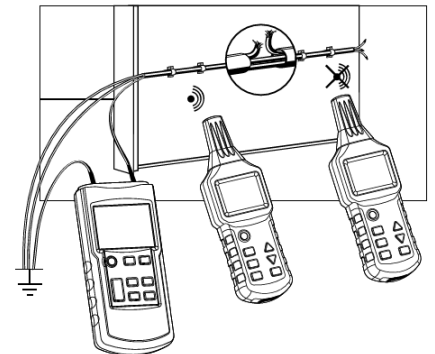

Fig. 3-1-3

HINWEIS

1. Make sure there is a complete ground connection.
2. With single-pole display it is also possible to track lateral circuit junctions.
3. If the supply line getting signals from the transmitter is directly parallel to other wires (e.g. cable slots of channels) or if the wires cross, the signals will also be sent to the other wires.
4. During search and tracking the signal will be shown stronger as the receiver gets closer to the tracked leads.
5. Adjust the transmitter power to suit the different search radii.
6. The position you are searching for can be detected precisely by putting the receiver in manual mode and setting the right sensitivity.

VORSICHT

1. Make sure of complete grounding.
2. The transition resistance of a line break must be higher than 100 kOhm.
3. When finding breaks in multi-strand conductors, make sure that all the other wires in the shielded cable or lead are properly grounded. This is necessary to avoid cross-coupling of the signals fed in (through capacitive effect on the output connections). The tracking depth for shielded cables differs, since the individual strands in the cable are twisted around each other.

HINWEIS

1. The grounding connected to the transmitter can be an auxiliary ground, such as a grounded socket or a properly grounded water pipe.
2. During tracking, at the break location there will be an abrupt decline in the signal shown at the receiver.
3. Adjust the transmitter power to suit the different search radii.
4. The position you are searching for can be detected precisely by putting the receiver in manual mode and setting the right sensitivity.

5.1.4 Detecting line breaks with two transmitters

When locating a line break with one transmitter supplied from one lead end, breaks cannot be precisely located due to field interference in unfavourable conditions. These limitations can be ameliorated by connecting two transmitters, one at each end. In this case each transmitter is set to a different lead code, e.g. Transmitter 1 to Code F and Transmitter 2 to Code C. (A second transmitter with a different lead code is not included in the scope of delivery, and must be ordered separately.)

Requirements:

- The circuit must not be live.
- All unused leads must be connected to ground as shown in Fig. 3-1-4.
- Connect and use both transmitters per Fig. 3-1-4.
- Proceed as in the example application.

If the transmitters are connected per Fig. 3-1-4, receiver C will show the line break on the left. If the receiver is moved to the right over the break, it will show F. If you are directly on the break, due to the overlapping of both transmitter signals no line code will be shown.

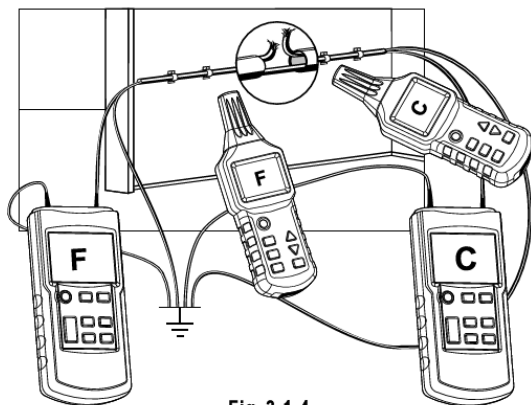

Fig. 3-1-4

HINWEIS

1. Adjust the transmitter power to suit the different search radii.
2. The position you are searching for can be detected precisely by switching the receiver to manual mode and setting the right sensitivity.

⚠ VORSICHT

1. Make sure of complete grounding.
2. The transition resistance of a line break must be higher than 100 kOhm.
3. The grounding connected to the transmitter can be the ground of a socket or a properly grounded water pipe.
4. When finding breaks in multi-strand cables, make sure that all the other wires in the shielded cable or lead are properly grounded. This is necessary to avoid cross-coupling of the signals fed in (through capacitive effect on the output connections). The tracking depth for shielded cables and leads differs, since the individual wires in the shielded cable are twisted around each other.

5.1.5 Fault detection in defective electric underfloor heating

Requirements:

- The circuit must not be live.
- All unused leads must be connected to auxiliary ground as shown in Fig. 3.1.5a.
- Connect both transmitters (if two will be used) as shown in Fig. 3-1-5b.
- Proceed as in the example application.

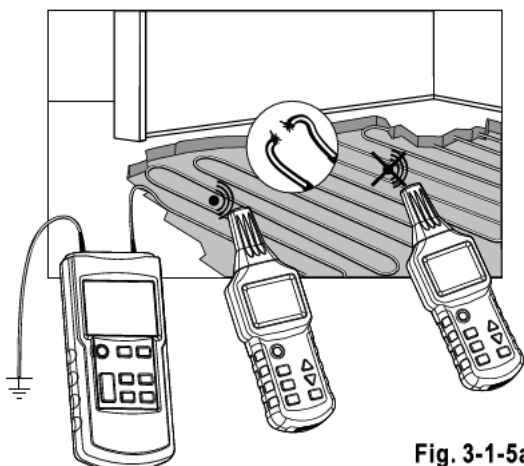

Fig. 3-1-5a

⚠ VORSICHT

1. If a shielding mat is laid on heating wires, there must be no ground connection. If necessary remove the shielding from the ground connection.
2. Ensure that there is complete grounding and enough distance between the ground connection of the transmitter and the line being searched for. If the distance is too small, the signal and the line cannot be precisely located.

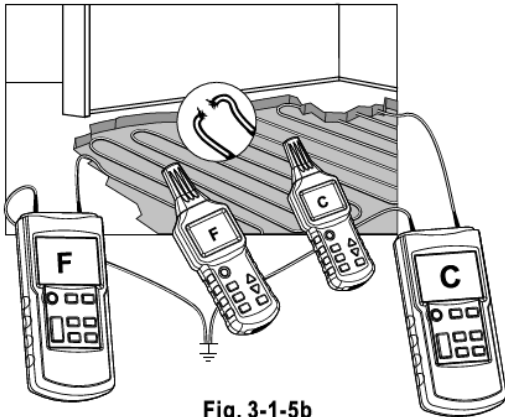

Fig. 3-1-5b

5.1.6 Locating blockages in non-conductive lines

HINWEIS

1. During tracking, at the break location there will be an abrupt decline in the signal shown at the receiver.
2. Adjust the transmitter power to suit the different search radii.
3. The position you are searching for can be detected precisely by switching the receiver to manual mode and setting the right sensitivity.
4. A second transmitter is not absolutely necessary for this application. For using just one transmitter, see Fig. 3-5-1a.

Requirements:

- The pipeline must be of non-conductive material (such as plastic).
 - The pipeline must not be electrically charged.
 - The transmitter must be connected to a metallic pipe coil (metallic pipe or flexible protective pipe) and an auxiliary ground as shown in Fig. 3-1-6.
 - Use the measurement procedure as shown in the example.
1. If the pipeline is carrying electrical current, the current must be switched off and the pipeline must be grounded.
 2. Connect the grounding wire in accordance with applicable regulations. The transmitter should have enough distance to the pipeline being measured. If the distance is too small, the signal and the modelled circuit cannot be precisely located.

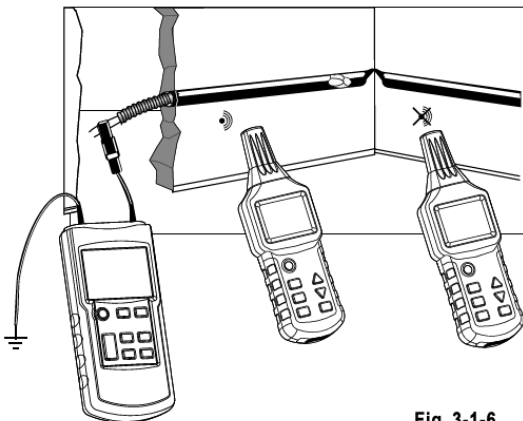

Fig. 3-1-6

HINWEIS

1. If you find only a pipeline made of non-conductive material (like glass fibre), we recommend inserting a metal wire with about 1.5 mm² cross-section into the non-conductive pipe and to the narrow or blocked section.
2. The stronger the signal shown on the receiver, the closer the receiver is to the pipeline under test.
3. When the signals to the receiver suddenly get weaker during testing along the pipeline, the problem area has been found.
4. Adjust the transmitter power to suit the different search radii. Set the receiver to manual mode and set the right sensitivity to precisely locate the problem area.

5.1.7 Locating metal water and heating pipes

Requirements:

- The pipe must be of metal (e.g. galvanized steel pipe).
- The pipeline must not be grounded. There should be relatively high resistance between pipe and floor (otherwise the search range will be very small).
- Use a wire to connect the grounding plug on the transmitter to ground.
- Use a wire to connect the “+” plug on the transmitter with the pipeline under test.

Locating water and heating pipes is shown in Fig. 3-1-7a and Fig. 3-1-7b

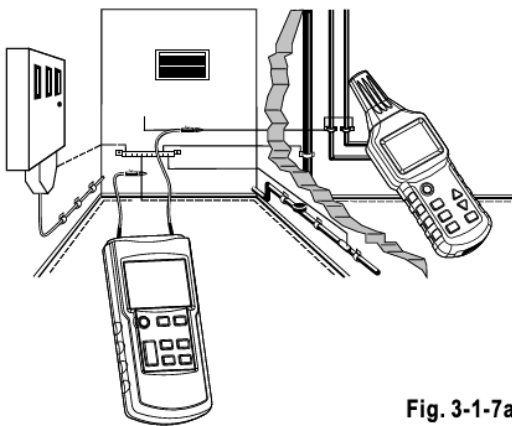

Fig. 3-1-7a

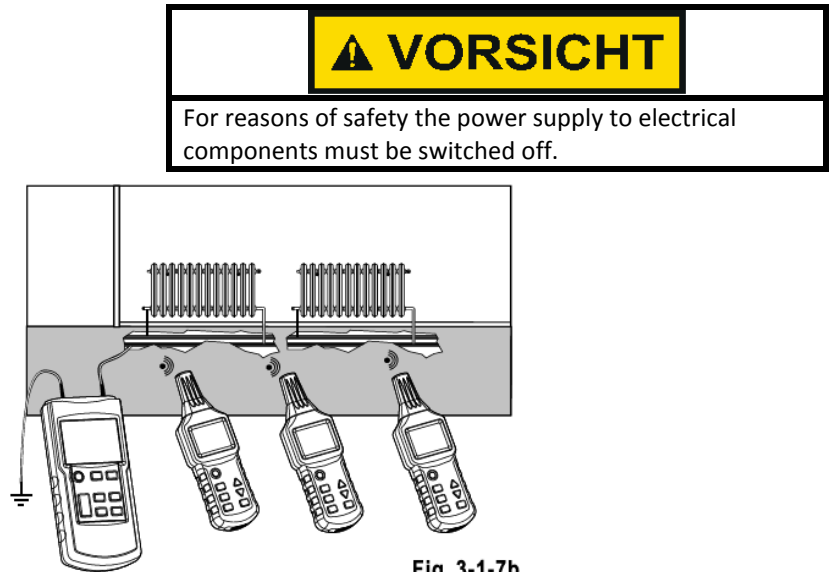

Fig. 3-1-7b

HINWEIS

1. The end of the transmitter ground conductor should be at a certain distance from the pipeline under test. If the distance is too small, the signal and the circuit cannot be precisely located.
2. Adjust the transmitter power to suit the different search radii.
3. The stronger the signals shown on the receiver display, the closer the pipeline is.
4. Set the receiver to manual mode and set the right sensitivity to precisely locate the pipeline.
5. To find a pipeline made of non-conductive material, we recommend inserting a metallic wire into the pipeline as described in 5.1.6.

5.1.8 Finding a circuit in a storey

When searching for a circuit in the same storey, proceed as follows:

- 1) Switch off the main switch in the switchgear cabinet for the storey.
- 2) Disconnect the neutral lead in the switchgear cabinet for this storey from the neutral leads for other storeys.
- 3) Connect the transmitter as shown in Fig. 3-1-8.

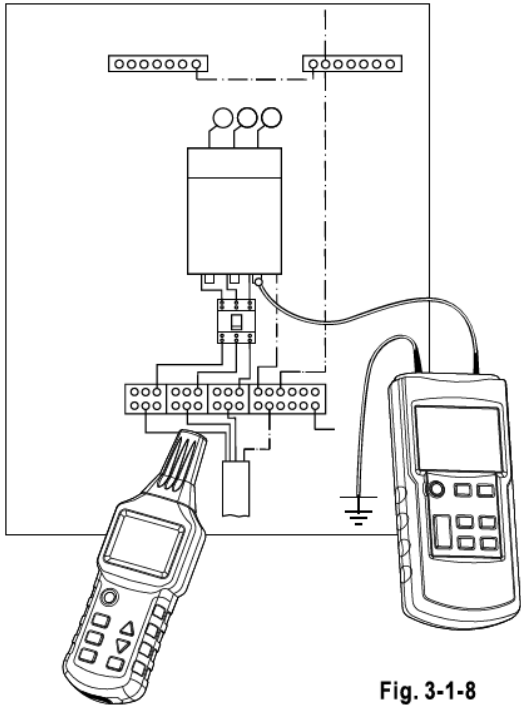

Fig. 3-1-8

⚠ WARNING

For reasons of safety switch off the power supply of the entire building. Make it without electricity.

HINWEIS

1. The end of the transmitter ground conductor should be correctly grounded and at a certain distance from the pipeline being searched for. If the distance is too small, the signal and the circuit cannot be precisely located.
2. Adjust the transmitter power to suit the different search radii.
3. The stronger the signals shown on the receiver display, the closer the pipeline is.
4. Set the receiver to manual mode and set the right sensitivity to precisely trace the pipeline.

5.1.9 Tracking lines under plaster

Requirements:

- The circuit must be voltage-free.
- Connect the transmitter as shown in Fig. 3-1-9.
- The transmitter ground conductor must be correctly grounded.
- Set the receiver to automatic mode.
- Use the indicated signal strength to locate or trace the circuit.

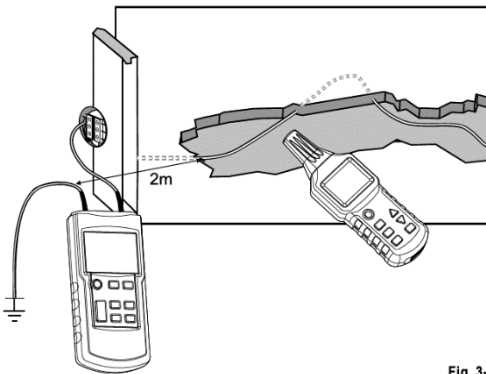

Fig. 3-1-9

⚠ VORSICHT

1. The distance between the ground lead and the circuit being searched must be as large as possible. If the distance is too small, the signal and the circuit cannot be precisely located.
2. The search depth is very dependent on the floor condition. Set a suitable receiver sensitivity in order to precisely locate the circuit.
3. Moving the receiver slowly along the circuit under test, you will notice that the display changes often. The strongest signals show where the circuit is.
4. The greater the distance between transmitter and receiver, the lower the signal strength and the weaker the search.

5.2 Two-pole use

5.2.1 Use in closed circuits

This procedure can be used when voltage is applied, or when voltage is not applied.

In uncharged circuits the transmitter only sends coder signals to the circuit to be found.

In live circuits the transmitter only sends coder signals to the circuit to be found, but also measures and shows the voltage of the charged circuit as shown in Fig. 3-2-1.

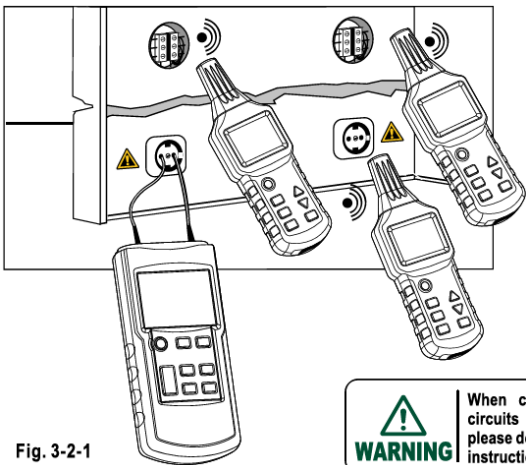

Fig. 3-2-1

HINWEIS

1. The upper electric limit of the transmitter is 400 V AC/DC.
2. Use in closed circuits is suitable for finding plugs, switches, fuses etc. in electric installations of wires carrying and not carrying electrical voltage.
3. The search depth depends on the material of the cable and the way it is used. The normal search depth is less than 0.5 mm.
4. Adjust the transmitter power to suit the different search radii.

⚠️ WARNUNG

Please make sure to follow the safety instructions for working with electrical power when connecting live circuits to the transmitter.

5.2.2 Detecting fuses

In a building with multiple apartments, use connections L and N on the socket of one of the apartments to send the signals from the transmitter (as shown in Fig. 3 22), and set the transmitter power to a suitable level.

Requirements:

- Switch off all fuses in the distributor box.
- Connect the transmitter per Fig. 3-2-2.

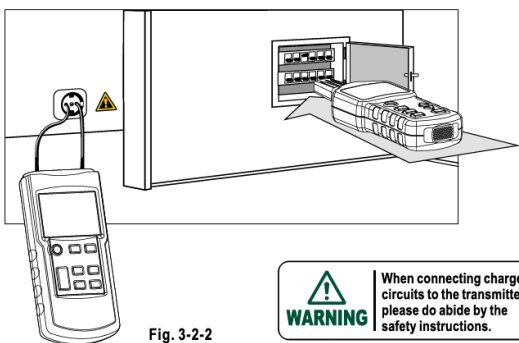

⚠ WARNING

Make sure to follow the safety instructions when connecting live circuits to the transmitter.

⚠ VORSICHT

1. The identification and positioning of fuses depend very much on the wiring situation in the distributor box. In order to locate fuses as precisely as possible, the cover of the distributor box should be opened or removed, and the fuse supply line located.
2. When searching, the fuse with the strongest and most stable signal is the one you are looking for. Due to signal coupling the searcher can detect the signals of other fuses, but these signals are usually fairly weak.

HINWEIS

1. When searching it is better to insert the search sensor in the fuse box opening to get the best search results.
2. Adjust the transmitter power to suit the different search radii. Set the receiver to manual mode and set the right sensitivity to precisely locate the circuit.

5.2.3 Locating the cause of a short-circuit

Requirements:

- The circuit must be voltage-free.
- Connect the transmitter per Fig. 3-2-3.
- The measurement procedure is the same as shown in the example.

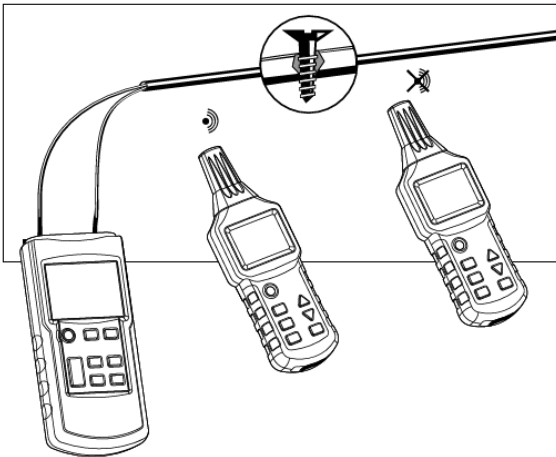

Fig. 3-2-3

⚠ VORSICHT

1. If the line is live, first turn the power off and make the circuit voltage-free.
2. When searching for short-circuits in coated electric lines and cables, the search depth will vary as the centre wires in the sheath are twisted around each other. Our experience has been that only short-circuits with an impedance lower than 20 Ohms can be correctly detected. The impedance of the short-circuit can be determined with a multimeter.

HINWEIS

1. If the impedance of the short-circuit is higher than 20 Ohms, try using the procedure for locating interruptions in circuits to find the short-circuit. Use a relatively high current to connect the faulty component (low Ohm connection) or interrupt it.
2. When the signals to the receiver suddenly get weaker during testing along the line, the location of the short-circuit has been found.
3. Adjust the transmitter power to suit the different search radii.
4. Set the receiver to manual mode and set the right sensitivity to precisely locate the circuit.

5.2.4 Locating deeply covered power cables

In two-pole use the search depth is severely limited if the ring conductor consists of centre wires as in multi-strand cables (such as NYM 3x1.5 mm²), because the short distance between the supply line and the ring conductor generates a highly distorted magnetic field. A sufficiently strong magnetic field cannot be established at the narrow places. If a separate ring conductor is used, the problem can be solved simply, since the separate conductor can spread out the magnetic field more. The ring conductor can be some kind of conductive wires or wire rolls. The important thing is that the interval between supply line and ring conductor be greater than the depth at which the cable is laid. In practice this interval is usually 2 m or more.

Requirements:

- The circuit must be voltage-free.
- Connect the transmitter as shown in Fig. 3-2-4.
- The interval between supply line and ring conductor must be at least 2~2.5 m.
- The measurement procedure is the same as shown in the example.

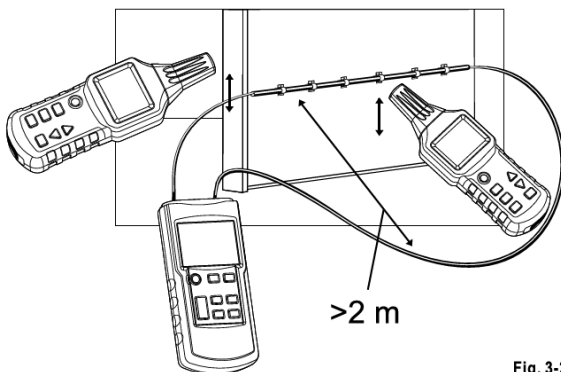

Fig. 3-2-4

HINWEIS

1. In this application, moisture or mortar in the wall has no influence down to the search depth.
2. The stronger the signals shown on the receiver display while searching the circuit, the closer the cable.
3. Adjust the transmitter power to suit the different search radii.
4. Set the receiver to manual mode and set the right sensitivity to precisely locate the circuit.

5.2.5 Classifying or identifying a covered circuit

Requirements:

- The circuit must be voltage-free.
- The ends of the centre wires must be twisted together and conductive to each other.
- Connect the transmitter as shown in Fig. 3-2-5.
- The measurement procedure is the same as shown in the example.

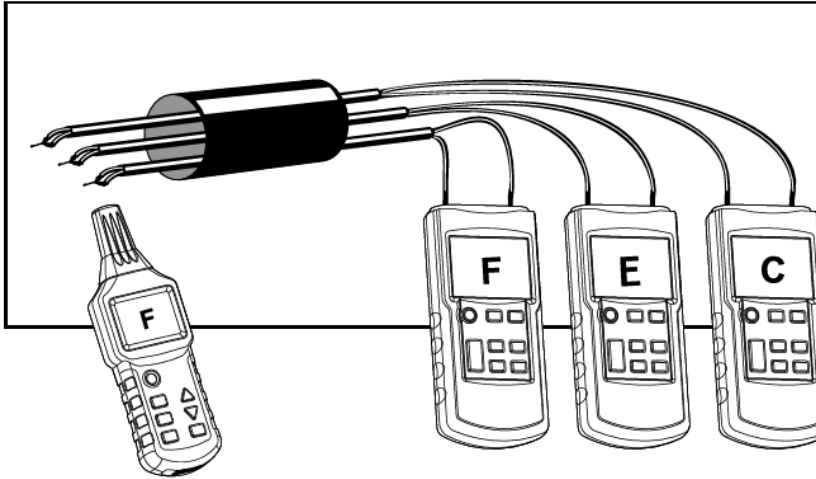

Fig. 3-2-5

⚠ VORSICHT

1. If the cable is live, first switch off the current to make the cable free of current.
2. The ends of the unshielded centre wires must be twisted together and conductive to each other.
3. If using only one transmitter, run multiple tests by
4. changing the connection between the transmitter and centre wire.

HINWEIS

1. Changing the connection between the transmitter and centre wire makes it possible to distinguish between different circuit when the transmission coding changes.
2. Adjust the transmitter power to suit the different search radii.
3. If necessary, purchase a transmitter with different transmission signals.

5.3 Method to increase the effective radius when detecting live circuits

When the transmitter is connected directly to the phase and neutral conductors the signals are fed to two parallel circuit (as shown in Fig. 3-3-1). Therefore, circuits can sometimes cause signals that counteract each other, leading to an effective search radius of no more than 0.5 m. In order to eliminate this effect, the connection must be made as shown in Fig. 3-3-2, where the ring conductor uses a separate cable, in order to increase the effective radius to over 2.5 m. Ring conductors over longer distances can be made with a wire roll (see Fig. 3-3-2).

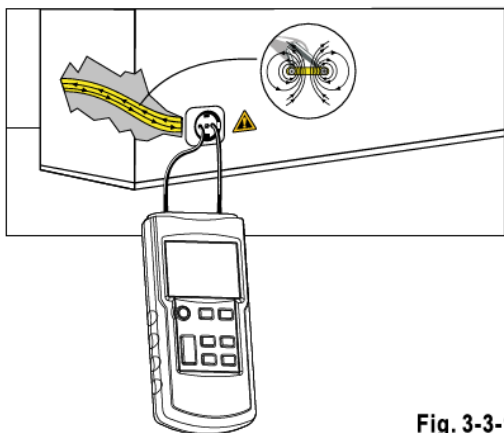

Fig. 3-3-1

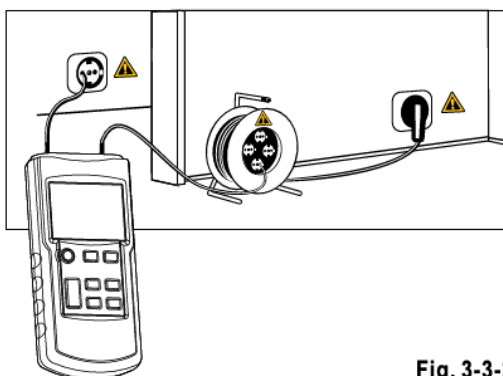

Fig. 3-3-2

⚠️ WARNUNG

Make sure to follow the safety instructions when connecting live circuits to the transmitter.

⚠️ VORSICHT

Pay attention to the right distance between the transmitter and the circuit under search, so that the circuit is clearly identifiable via signals.

HINWEIS

1. The stronger the signals shown on the receiver display while searching the circuit, the closer the cable.
2. Adjust the transmitter power to suit the different search radii.
3. Set the receiver to manual mode and set the right sensitivity to precisely locate the circuit.

5.4 Identifying grid voltage and searching for breaks in circuits

Requirements:

- The circuit must have AC voltage.
- Measurement must be performed as shown in Fig. 3-4.
- Set the transmitter to “grid identification” (UAC) mode.

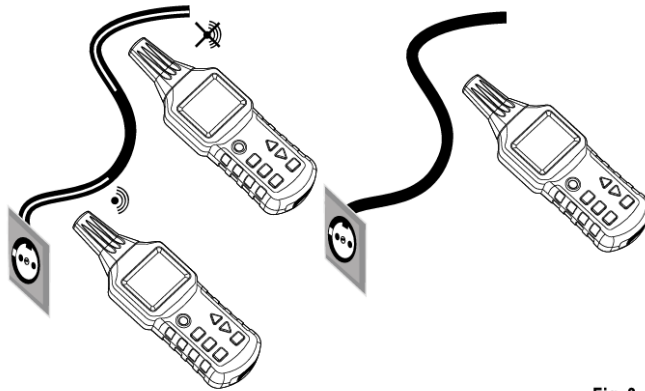

Fig. 3-4

VORSICHT

1. The AC signals found by the transmitter in UAC mode only show whether the circuit has current; determination of the exact voltage is done with the voltage measurement function of the transmitter.
2. When searching for the ends of compound cables, each wire must be separately connected to the phase conductor.

HINWEIS

1. A transmitter is not necessary for this application (unless you want to use the measurement function of the transmitter to determine the voltage in the circuit).
2. The columns shown on the transmitter for signal strength and signal tone frequency are associated with the voltage in the circuit under search and the distance from it. The higher the voltage and the less the distance to the circuit, the more columns are shown and the higher the signal tone frequency.

6. Other functions

6.1 Voltmeter function of the transmitter

When the transmitter is connected to a live circuit and the external voltage is higher than 12 V, the voltage will be shown at the bottom left of the transmitter monitor using standard symbols to differentiate between AC and DC circuits (see (4), (5) and (6) on the interface shown on the transmitter), and at the top of the monitor there will be a lightning symbol with a triangular frame (see (10) on the interface shown on the transmitter). The identification range is 12~400 V DC/AC (AC: 50~60 Hz).

6.2 Flashlight function

Press the “Flashlight” key, (9) on the transmitter or (6) on the receiver to turn on the flashlight function. To turn it off, press the key again.

6.3 Background lighting

Press the “Background lighting” key (5) on the receiver to turn on the Background lighting. To turn it off, press the key again. The transmitter does not have a background lighting function.

6.4 Silent function

Press the “Silent mode” key (8) on the transmitter to turn off the buzzer. The buzzer will now not make any noise when a key is pressed. Press the “Silent mode” key on the transmitter again to switch off silent mode and restore buzzer function. On the receiver, press the “Background lighting/Silent mode” key (5) for 1 second to turn off the sound. Now the buzzer and loudspeaker of the receiver will not sound. Press the “Background lighting/Silent mode” key (5) on the receiver for 1 second to turn the buzzer and loudspeaker back on.

6.5 Automatic switch-off

The transmitter does not have automatic switch-off. If no key is pressed on the receiver for a relatively long time, the receiver will switch itself off after about 10 minutes. Press the on/off button (2) to turn the transmitter back on.

7. Technical parameters

7.1 Technical parameters of the transmitter

Output signal		125kHz
External voltage identification range		DC 12~400V±2.5%; AC 12~400V(50-60Hz±2.5%;
Display		LCD with function display and column diagram
Dielectric stability, external voltage		Max. 400V AC/DC
Overvoltage type		CAT III 300V
Degree of contamination		2
Power supply		1x9V, ICE 6LR61
Power consumption	Min. amperage	approx. 31 mA
	Max. amperage	approx. 115 mA
Fuse		F 0.5A 500V, 6.3x32mm
Temperature range	Operation	0°C to 40°C, max. rel. humidity 80 % (no condensation)
	Storage	-20°C to 60°C, max. rel. humidity 80 % (no condensation)
Height		Max. 2000m
Dimensions (HxWxD)		190mm x 89mm x 42.5mm
Weight	Without battery	approx. 360g
	With battery	approx. 420g

7.2 Technical parameters of the receiver

Tracking depth		Tracking depth depends on the material and specific application
Cable search mode	Single-pole use	approx. 0~2m
	Multi-pole use	approx. 0~0.5m
	Single ring conductor	up to 2.5m
Grid voltage identification		up to 0~0.4m
Display		LCD with function display and column diagram
Power supply		6 x 1.5V AAA, IEC Lr03
Power consumption	Min. amperage	approx. 32 mA
	Max. amperage	approx. 89 mA
Temperature range	Operation	0°C to 40°C, max. rel. humidity 80 % (no condensation)
	Storage	-20°C to 60°C, max. rel. humidity 80 % (no condensation)
Height		Max. 2000m
Dimensions (HxWxD)		241.5mm x 78mm x 38.5mm
Weight	Without battery	Approx. 280g
	With battery	Approx. 350g

8. Repair and maintenance

1. If the detector does not appear to be working, first make sure that the batteries have enough power and the test lead is not defective.
2. Before sending the detector in for repair, take out the battery, describe the problem, and pack the device properly in order to prevent damage during shipping. We accept no liability for shipping damage.
3. There is a fuse in the transmitter. If this is damaged during the warranty period, it can be replaced only by technical customer service. If it is damaged after the warranty period, replace it with a new fuse of the same type. The fuse is a fast-melting single metal wire fuse; do not replace it with a slow spiral wire fuse, since otherwise transmission performance and device safety cannot be ensured.

8.1 Troubleshooting

If the detector is not working properly, check the points in the table below:

Malfunction	Points to check	Remedial measures
Device will not switch on	Is a battery installed?	Install new battery.
	Is the battery power too low?	
	Is the battery polarity correct?	Check the polarity.
Transmitter cannot identify external	Is the contact bad?	Reconnect lead.
	Is the sensor defective?	Replace sensor?

voltage	Is the sensor inserted all the way?	Insert sensor correctly.
	Is the test lead defective?	Replace test lead.
	Is the test lead inserted all the way?	Connect test lead correctly.
Power supply switches off during measurement	Is the battery power too low?	Install new battery.
	Did the device switch off automatically?	Turn it back on.
Transmitter cannot receive the signals it transfers	Was the "transfer" key pressed?	Restart transfer.
	Is the transmitter fuse defective?	Contact customer service.

8.2 Check the transmitter fuse.

The transmitter fuse can protect the transmitter from damage from overloading and improper use. If the transmitter fuse has melted down, the transmitter can only transfer weak signals. If the transmitter self-test was successful but the transferred signal is weak, it means that signal transfer is good but the fuse has melted. If no signal is detected in transfer mode during transmitter self-testing, the transmitter is defective and should be repaired by customer service.

Special procedure and steps to test the transmitter fuse:

- 1) Disconnect all measurement current circuits of the transmitter.
- 2) Turn on the transmitter and put it in transfer mode.
- 3) Set the transmission power to I.
- 4) Connect the end of the test lead terminal 10 of the transmitter.
- 5) Insert the other end of the test lead into the transmitter plug socket.
- 6) Turn on the transmitter in order to find the signals from the test lead, and move the receiver sensor towards the test lead.
- 7) If the fuse is not defective, the value shown on the receiver will double.

8.3 Cleaning

Use a damp cloth to clean the transmitter. If necessary use a neutral cleanser. The transmitter must then be towel-dried.

⚠ VORSICHT
<ol style="list-style-type: none">1. Before doing any cleaning make sure that the device is switched off and all circuits are disconnected.2. Do not use petrol, alcohol, acetone, ether, ketone, thinner or benzene for cleaning. These substances can deform or discolour the device.3. Make sure the device is thoroughly dry before using it.

8.4 Changing the battery

When the battery symbol on the display ((1) on the transmitter, (1), (2) on the receiver) and the buzzer give a warning signal, the battery needs to be changed. To do so (transmitter or receiver), proceed as follows:

- 1) Switch off the device and disconnect all measurement circuits.
- 2) Unscrew the back panel and remove the cover of the battery compartment.
- 3) Remove the used battery.
- 4) Insert a new battery in the correct direction (polarity).
- 5) Put the cover of the battery compartment back on and screw it down.

⚠ WARNING
<ol style="list-style-type: none">1. When putting in the battery, make sure the poles are in the right direction. If the battery polarity is wrong the device will be damaged. It can also explode or catch fire.2. Do not connect the two poles of the battery with a conductive wire, and do not put the battery in a fire, as it can explode.3. Never attempt to disassemble the battery! The electrolyte in it is highly alkaline and can cause chemical burns. If the electrolyte comes into contact with skin or clothing, rinse the affected areas with fresh water. If the electrolyte gets into the eyes, immediately rinse the eyes with fresh water and get medical treatment.
⚠ VORSICHT
<ol style="list-style-type: none">1. Before replacing the battery the device must be switched off, all measurement circuits must be disconnected, and all conductive wires used for measurement must be removed.2. Use only the battery type specified in the Technical parameters.3. If the device will not be used for an extended period, remove the battery. If the detector is contaminated by a leaking battery, send it to the manufacturer for cleaning and inspection.4. When disposing of used batteries, follow applicable rules for recycling, reclamation and disposal.

8.5 Calibration

To make sure that the measurements made by the detector are accurate, it must be regularly calibrated by company personnel. The recommended calibration interval is a year. If the detector is used frequently or under difficult conditions, it should be calibrated more often. If it is used only seldom, the calibration interval can be extended up to three years.

9. Addresses

Customer Service : Tel.: +49 (4281) 712-0
Fax: +49 (4281) 712-49

Address : Wilhelm Fricke SE
Zum Kreuzkamp 7
D-27404 Heeslingen

10. Legal Notice

Original manufacturer declaration for cable detector
Manufacturer: Wilhelm Fricke SE - D-27404 Heeslingen
1st edition, October 2016
©2016 Wilhelm Fricke GmbH
Reproduction in whole or in part is prohibited without the written consent of the Wilhelm Fricke GmbH company.
All names of products mentioned in this manual are trademarks of their respective companies.
Printed on paper made from chlorine and acid-free bleached pulp.